

## N-Channel Super Junction Power MOSFET IV

### General Description

The series of devices use advanced trench gate super junction technology and design to provide excellent  $R_{DS(ON)}$  with low gate charge. This super junction MOSFET fits the industry's AC-DC SMPS requirements for PFC, AC/DC power conversion, and industrial power applications.

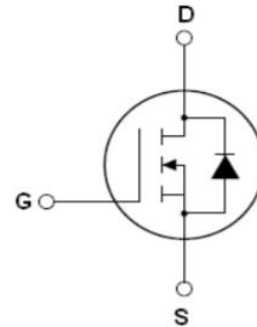
### Features

- Optimized body diode reverse recovery performance
- Low on-resistance and low conduction losses
- Small package
- Ultra Low Gate Charge cause lower driving requirements
- 100% Avalanche Tested
- ROHS compliant

### Application

- Power factor correction (PFC)
- Switched mode power supplies(SMPS)
- Uninterruptible Power Supply (UPS)
- LLC Half-bridge

$V_{DS\ min@T_{jmax}}$	710	V
$R_{DS(ON)TYP.}$	1050	m $\Omega$
$I_D$	3.8	A
$Q_g$	10	nC



Schematic diagram

### Package Marking And Ordering Information

Device	Device Package	Marking
NCE65N1K2R	SOT-223-2L	NCE65N1K2R



SOT-223-2L

Table 1. Absolute Maximum Ratings ( $T_c=25^\circ\text{C}$ )

Parameter	Symbol	Value	Unit
Drain-Source Voltage ( $V_{GS}=0V$ )	$V_{DS}$	650	V
Gate-Source Voltage ( $V_{DS}=0V$ ), AC ( $f>1\text{ Hz}$ )	$V_{GS}$	$\pm 30$	V
Gate-Source Voltage ( $V_{DS}=0V$ ), DC	$V_{GS}$	$\pm 20$	V
Continuous Drain Current at $T_c=25^\circ\text{C}$	$I_{D(DC)}$	3.8	A
Continuous Drain Current at $T_c=100^\circ\text{C}$	$I_{D(DC)}$	2.66	A
Pulsed drain current (Note 1)	$I_{DM(pluse)}$	11.4	A
Maximum Power Dissipation( $T_c=25^\circ\text{C}$ )	$P_D$	3.4	W
Derate above $25^\circ\text{C}$		0.023	W/ $^\circ\text{C}$
Single pulse avalanche current (Note 2)	$I_{AS}$	1	A
Reverse diode $dv/dt$ , $V_{DS} \leq 480\text{ V}, I_{SD} < I_D$	$dv/dt$	15	V/ns
Drain Source voltage slope, $V_{DS} \leq 480\text{ V}$	$dv/dt$	50	V/ns
Operating Junction and Storage Temperature Range	$T_J, T_{STG}$	-55...+175	$^\circ\text{C}$

**Table 2. Thermal Characteristic**

Parameter	Symbol	Value	Unit
Thermal Resistance, Junction-to-Case (Maximum)	$R_{thJC}$	44.1	$^{\circ}C/W$
Thermal Resistance, Junction-to-Ambient (Maximum)	$R_{thJA}$	62	$^{\circ}C/W$

**Table 3. Electrical Characteristics (TA=25°C unless otherwise noted)**

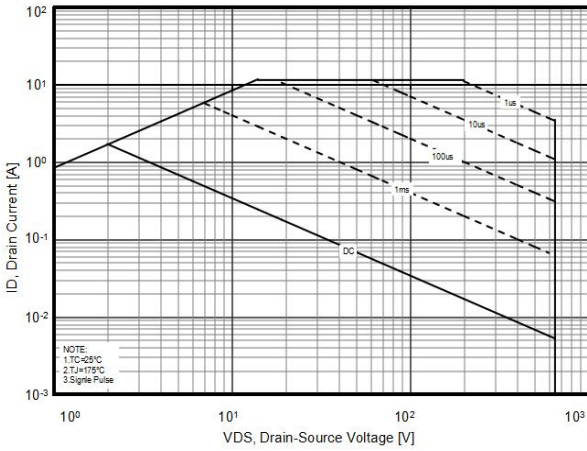
Parameter	Symbol	Condition	Min	Typ	Max	Unit
<b>On/off states</b>						
Drain-Source Breakdown Voltage	$BV_{DSS}$	$V_{GS}=0V, I_D=250\mu A$	650			V
Zero Gate Voltage Drain Current( $T_c=25^{\circ}C$ )	$I_{DSS}$	$V_{DS}=650V, V_{GS}=0V$			1	$\mu A$
Zero Gate Voltage Drain Current( $T_c=125^{\circ}C$ )	$I_{DSS}$	$V_{DS}=650V, V_{GS}=0V$			50	$\mu A$
Gate-Body Leakage Current	$I_{GSS}$	$V_{GS}=\pm 20V, V_{DS}=0V$			$\pm 100$	nA
Gate Threshold Voltage	$V_{GS(th)}$	$V_{DS}=V_{GS}, I_D=250\mu A$	3		4	V
Drain-Source On-State Resistance	$R_{DS(ON)}$	$V_{GS}=10V, I_D=1.9A$		1050	1200	m $\Omega$
<b>Dynamic Characteristics</b>						
Gate Resistance	$R_g$	$F=1MHz, D-S$ short		34		$\Omega$
Input Capacitance	$C_{iss}$	$V_{DS}=50V, V_{GS}=0V,$ $F=1MHz$		316		pF
Output Capacitance	$C_{oss}$			12		pF
Reverse Transfer Capacitance	$C_{riss}$			5		pF
Total Gate Charge	$Q_g$	$V_{DS}=480V, I_D=2A,$ $V_{GS}=10V$		10	12	nC
Gate-Source Charge	$Q_{gs}$			1.1		nC
Gate-Drain Charge	$Q_{gd}$			7.5		nC
Gate plateau voltage	$V_{gp}$			5.3		V
<b>Switching times</b>						
Turn-on Delay Time	$t_{d(on)}$	$V_{DD}=480V, I_D=2A,$ $R_G=4\Omega, V_{GS}=10V$		8		nS
Turn-on Rise Time	$t_r$			10		nS
Turn-Off Delay Time	$t_{d(off)}$			41		nS
Turn-Off Fall Time	$t_f$			9		nS
<b>Source- Drain Diode Characteristics</b>						
Source-drain current(Body Diode)	$I_{SD}$	$T_c=25^{\circ}C$			3.8	A
Pulsed-Source-drain current(Body Diode)	$I_{SDM}$				11.4	A
Forward on voltage	$V_{SD}$	$T_j=25^{\circ}C, I_{SD}=3.8A, V_{GS}=0V$		1.0	1.2	V
Reverse Recovery Time	$t_{rr}$	$T_j=25^{\circ}C, I_F=2A,$ $di/dt=100A/\mu s$		185		nS
Reverse Recovery Charge	$Q_{rr}$			0.55		$\mu C$
Peak reverse recovery current	$I_{rrm}$			6		A

Notes: 1. Repetitive Rating: Pulse width limited by maximum junction temperature

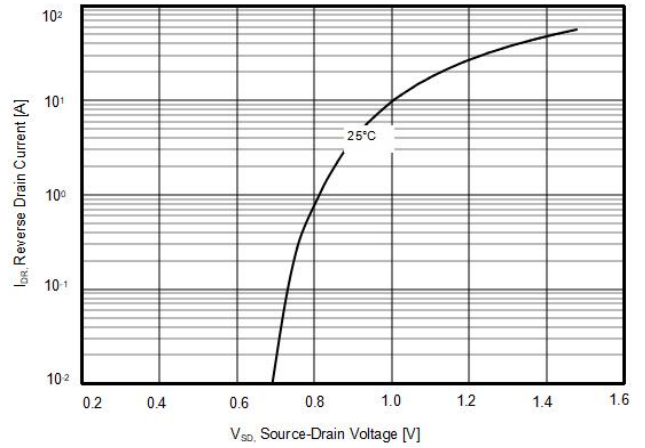
2.  $T_j=25^{\circ}C, V_{DD}=50V, V_G=10V, R_G=25\Omega$

## TYPICAL ELECTRICAL AND THERMAL CHARACTERISTICS (curves)

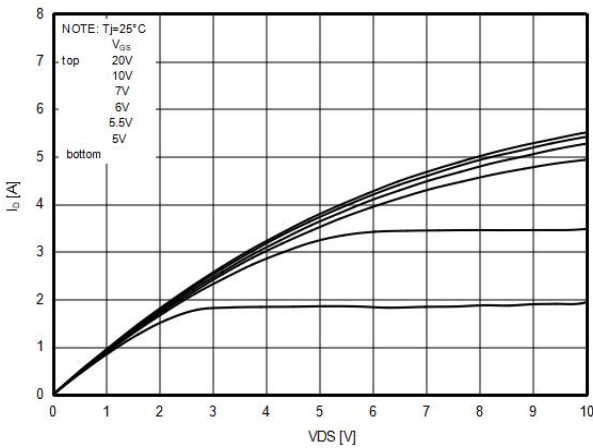
**Figure1. Safe operating area**



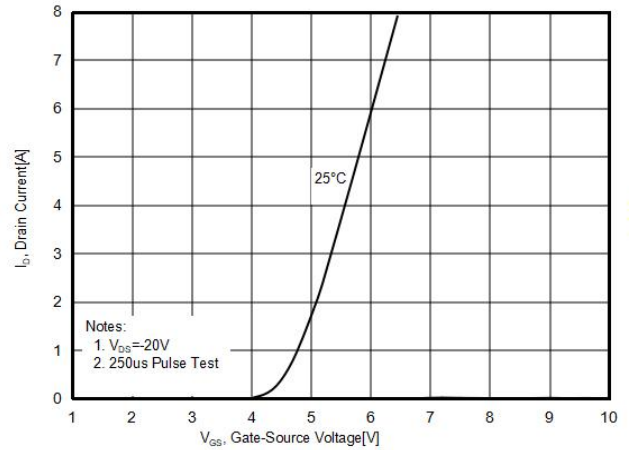
**Figure2. Source-Drain Diode Forward Voltage**



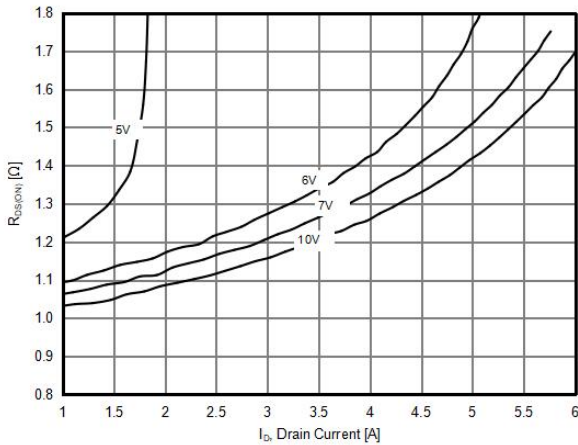
**Figure3. Output characteristics**



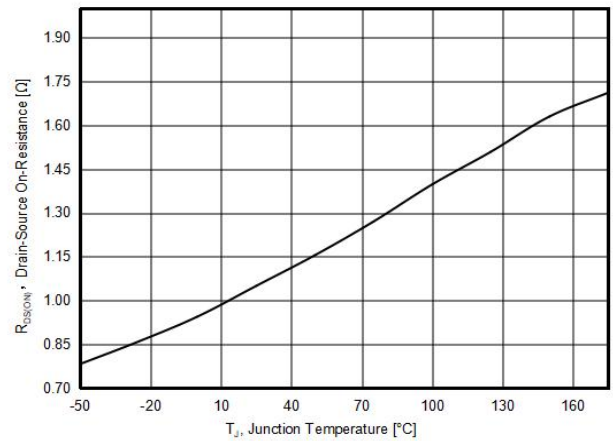
**Figure4. Transfer characteristics**



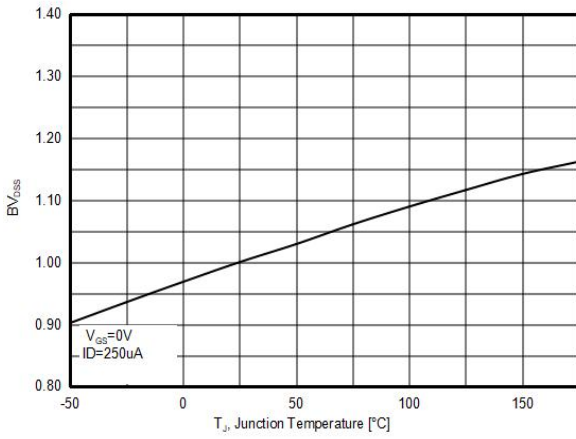
**Figure5. Static drain-source on resistance**



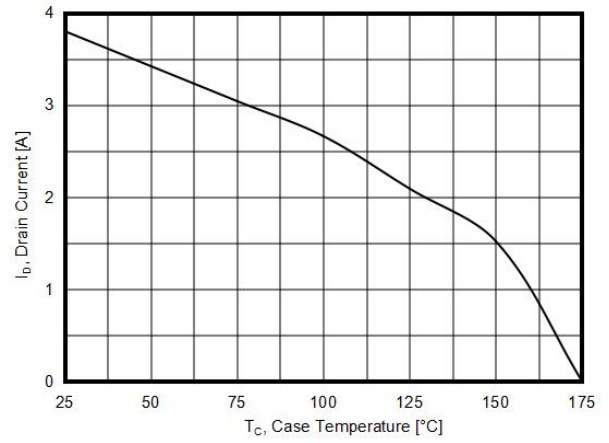
**Figure6.  $R_{DS(ON)}$  vs Junction Temperature**



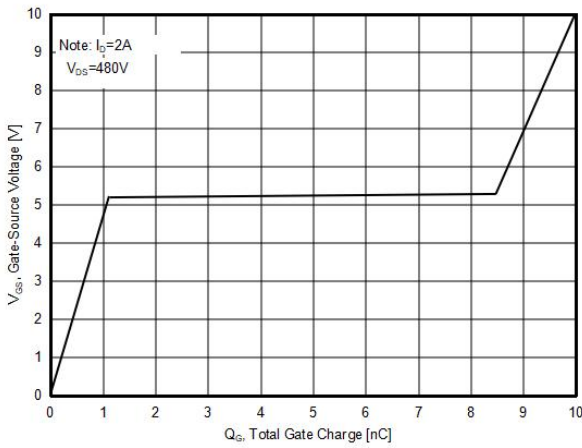
**Figure7. BV<sub>DSS</sub> vs Junction Temperature**



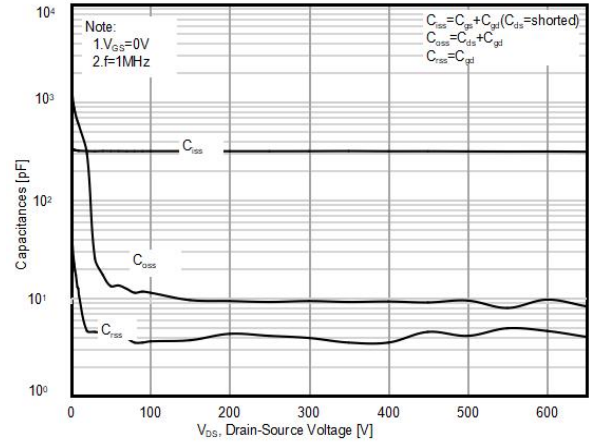
**Figure8. Maximum I<sub>D</sub> vs Junction Temperature**



**Figure9. Gate charge waveforms**

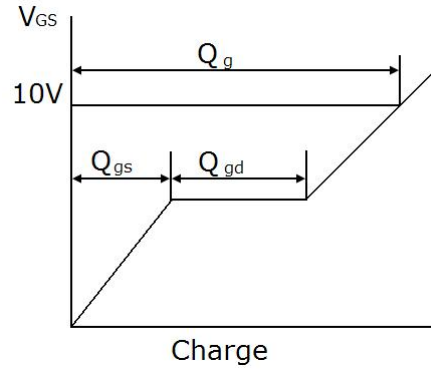
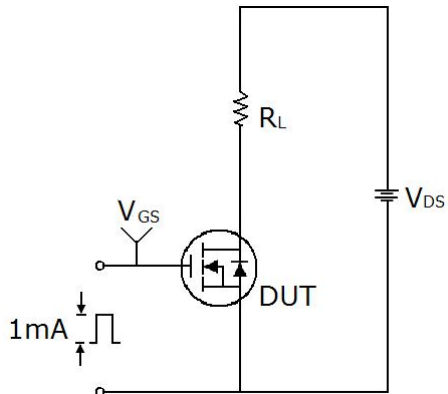


**Figure10. Capacitance**

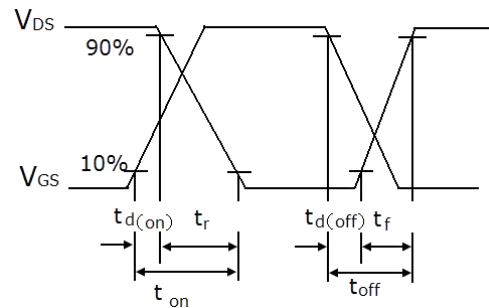
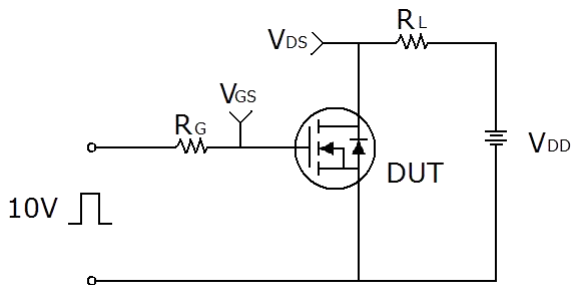


## Test circuit

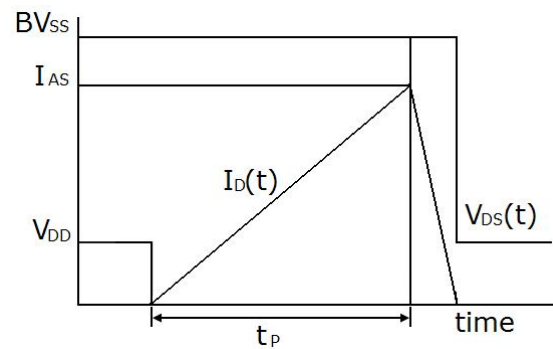
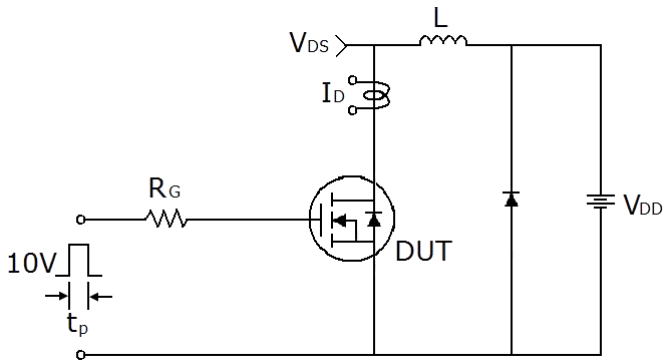
### 1) Gate charge test circuit & Waveform



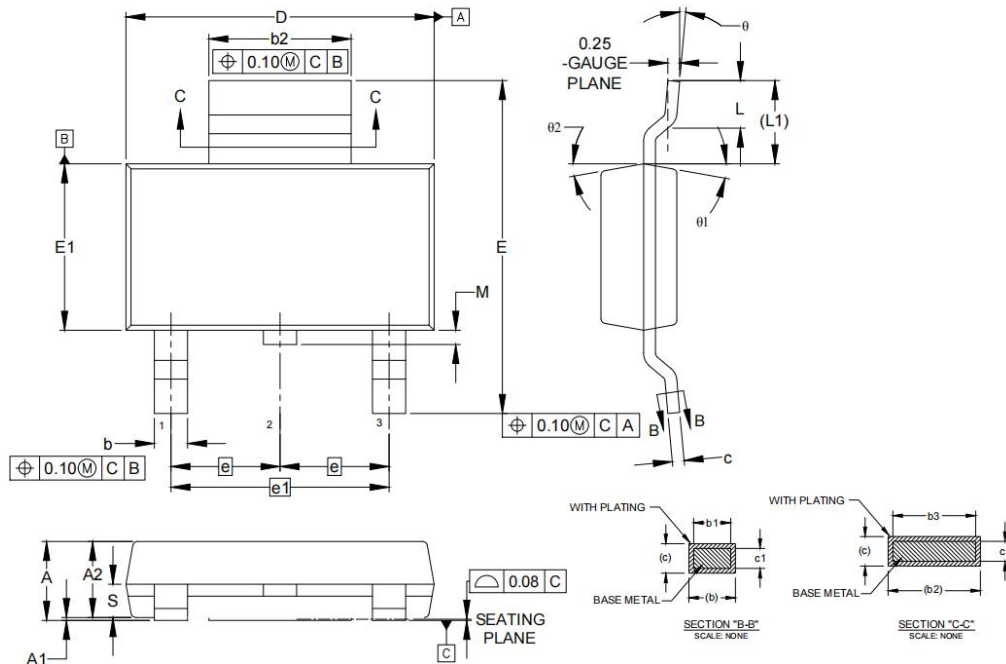
### 2) Switch Time Test Circuit:



### 3) Unclamped Inductive Switching Test Circuit & Waveforms



## SOT-223-2L Package Information



Symbol	Dimensions In Millimeters		Dimensions In Inches	
	Min.	Max.	Min.	Max.
A	1.52	1.80	0.060	0.071
A1	0.02	0.10	0.001	0.004
A2	1.50	1.70	0.059	0.067
b	0.60	0.80	0.024	0.031
b1	0.60	0.78	0.024	0.031
b2	2.95	3.10	0.116	0.122
b3	2.95	3.05	0.116	0.120
c	0.24	0.32	0.009	0.013
c1	0.24	0.30	0.009	0.012
D	6.30	6.70	0.248	0.264
E	6.70	7.30	0.264	0.287
E1	3.30	3.70	0.130	0.146
e	2.30 BSC.		0.091 BSC.	
e1	4.60 BSC.		0.182 BSC.	
L	0.90	1.10	0.035	0.043
L1	1.75 REF		0.069 REF	
M	---	0.50	---	0.020
S	0.70 REF		0.028 REF	
θ	0°	10°	0°	10°
θ1	10° REF		10° REF	
θ2	10° REF		10° REF	

---

## ATTENTION:

- Any and all NCE products described or contained herein do not have specifications that can handle applications that require extremely high levels of reliability, such as life-support systems, aircraft's control systems, or other applications whose failure can be reasonably expected to result in serious physical and/or material damage. Consult with your NCE representative nearest you before using any NCE products described or contained herein in such applications.
- NCE assumes no responsibility for equipment failures that result from using products at values that exceed, even momentarily, rated values (such as maximum ratings, operating condition ranges, or other parameters) listed in products specifications of any and all NCE products described or contained herein.
- Specifications of any and all NCE products described or contained herein stipulate the performance, characteristics, and functions of the described products in the independent state, and are not guarantees of the performance, characteristics, and functions of the described products as mounted in the customer's products or equipment. To verify symptoms and states that cannot be evaluated in an independent device, the customer should always evaluate and test devices mounted in the customer's products or equipment.
- NCE Power Semiconductor CO.,LTD. strives to supply high-quality high-reliability products. However, any and all semiconductor products fail with some probability. It is possible that these probabilistic failures could give rise to accidents or events that could endanger human lives, that could give rise to smoke or fire, or that could cause damage to other property. When designing equipment, adopt safety measures so that these kinds of accidents or events cannot occur. Such measures include but are not limited to protective circuits and error prevention circuits for safe design, redundant design, and structural design.
- In the event that any or all NCE products(including technical data, services) described or contained herein are controlled under any of applicable local export control laws and regulations, such products must not be exported without obtaining the export license from the authorities concerned in accordance with the above law.
- No part of this publication may be reproduced or transmitted in any form or by any means, electronic or mechanical, including photocopying and recording, or any information storage or retrieval system, or otherwise, without the prior written permission of NCE Power Semiconductor CO.,LTD.
- Information (including circuit diagrams and circuit parameters) herein is for example only ; it is not guaranteed for volume production. NCE believes information herein is accurate and reliable, but no guarantees are made or implied regarding its use or any infringements of intellectual property rights or other rights of third parties.
- Any and all information described or contained herein are subject to change without notice due to product/technology improvement, etc. When designing equipment, refer to the "Delivery Specification" for the NCE product that you intend to use.
- This catalog provides information as of Mar. 2010. Specifications and information herein are subject to change without notice.